

U1000MkII WM

U1000MKII-WM: Wall-Mounted Ultrasonic Flow Meter Wall-Mounted
Ultrasonic Heat Meter

User Manual



British Rototherm Company LTD.
Kenfig Industrial Estate, Margam, Port Talbot, SA13 2PW
United Kingdom

Telephone: +44(0)1656 740551 **E-mail:** sales@micronicsltd.co.uk

www.micronicsflowmeters.com

CONTENTS

1	INTRODUCTION	1
1.1	General Description	1
1.2	How Does It Work?	2
1.3	Package Contents	3
1.4	Display.....	5
1.5	Quick Start Procedure	6
1.6	Output and Communication Options	6
2	INSTALLATION.....	7
2.1	Identify Suitable Location	7
2.1.1	Additional Considerations for Locating Heat Meter versions	7
2.1.2	Clean the Pipe's Flow Sensor Contact Area	8
2.2	Connect Power and Signal Cables	8
2.2.1	Power Supply	8
2.2.2	Guiderail/Flow Sensors.....	8
2.2.3	PT100 Sensors (Heat Meter versions only)	9
2.2.4	Pulse Output Connection	9
2.2.5	Current Output (if fitted)	9
2.2.6	Modbus/MBUS Connections (if fitted)	10
2.3	Switch On	12
2.3.1	U1000MkII WM Flow Meter	12
2.3.2	U1000MkII WM Heat Meter	13
2.4	Assemble the Guiderail.....	14
2.5	Adjust Flow Sensor Separation.....	14
2.6	Apply Gel Pads.....	14
2.7	Clamp Guiderail to Pipe.....	14
2.8	Calibrate the PT100 Sensors (Heat Meter versions only).....	15
2.9	Attach the PT100 Sensors (Heat Meter versions only).....	15
2.10	Normal Operation	17
2.10.1	U1000MkII-WM Flow Meter	17
2.10.2	U1000MkII-WM Heat Meter	17
2.10.3	Troubleshooting the Flow Reading	18
3	MENUS	19
3.1	Accessing the Menus.....	19
3.2	Setup Menu	21
3.3	Current Output Menu (4-20mA versions only).....	22
3.4	Modbus Setup Menu (Modbus versions only)	23
3.5	M-Bus Setup Menu (M-Bus versions only).....	23
3.6	Pulse Output Menu	24

3.6.1	Volume Pulse	24
3.6.2	Flow Alarm	24
3.6.3	Energy Pulse (Heat Meter versions only)	25
3.6.4	Frequency	25
3.7	Calibration Menu	26
3.8	Volume Totals Menu	26
3.9	Diagnostics Menu	27
4	OUTPUTS	28
4.1	Pulse Output	28
4.1.1	Volumetric Pulse	28
4.1.2	Frequency Mode	29
4.1.3	Energy Pulse (Heat Meter versions only)	29
4.1.4	Flow Alarm - Low Flow	29
4.1.5	Flow Alarm – Signal Loss	29
4.2	4-20mA Current Output	29
4.3	Modbus (if fitted)	30
4.4	M-Bus (if fitted)	33
4.4.1	Acknowledge Function	33
4.4.2	Select Slave Function	34
4.4.3	Data Transfer Functions	34
4.4.4	REQ_UD2 – REQUEST DATA	35
4.4.5	RSP_UD2 – RETURN DATA	36
4.4.6	Switch Baud Rate Function	37
4.4.7	Change Primary Address Function	40
5	APPENDIX	41
5.1	Specification	41
5.2	Default values	43
5.3	Limitations with Water-Glycol Mixtures	43
5.4	Positioning	43
5.5	Error and Warning Messages	45
5.5.1	Error Messages	45
5.5.2	Example Error Messages	45
5.5.3	Modbus Error Messages (if Modbus fitted)	46
5.5.4	Flow Errors	46
5.5.5	Flow Warnings	46
5.5.6	Data Entry Errors	47
6	DECLARATION OF CONFORMITY	48

1 INTRODUCTION

1.1 General Description

This manual describes the installation and use of the two models in the U1000MkII WM range:

- **U1000MkII WM Flow Meter** is a wall-mounted control unit with a clamp-on ultrasonic flow sensors for measuring flow rate and total flow with a volume pulse output. It can be used as a standalone meter or as part of an integral management system.
- **U1000MkII WM Heat Meter** is a wall-mounted control unit with a clamp-on ultrasonic flow sensors and separate pair of PT100 thermal sensors. It uses ultrasound to measure flow rate and is also equipped with PT100 temperature sensors to measure flow and return temperatures. The U1000MKII WM Heat Meter displays energy rate and totalised energy with pulse output and communication options, so it can be used as a standalone meter or as an integral part of Automatic Monitoring & Targeting (aM&T) or a Building Energy Management System (BEMS).

The ultrasonic flow sensor attaches to the pipe using the supplied hose clips. The sensors operate on steel, stainless steel, copper and plastic pipes with internal diameter in the range 20mm (0.8") to 110mm (4.3"), or 105mm (4.1") to 215mm (8.5") depending on the product purchased. The wall-mounted electronics and control unit requires an external 12 - 24V AC/DC power supply (7VA minimum), optionally supplied.

Both models can be supplied as pulse output only units or with optional 4-20mA flow proportional output, and/or Modbus or M-Bus communication options.

Typical applications:

U1000MkII WM Flow Meter

Hot water metering and flow measurement
 Flow measurement for heat metering
 Chilled water metering and flow measurement
 Potable water metering and flow measurement
 Process water metering and flow measurement
 Ultra-pure water metering and flow measurement.

U1000MkII WM Heat Meter

Hot water metering and flow measurement
 Flow measurement for Energy Metering
 Chilled water metering and flow measurement

NOTE:

U1000MkII WM Heat Meter units are preconfigured as follows:

- **Instrument Type:** Heating
- **Installation:** Flow
- **Fluid:** Water

Flow and *Return* refer to the location of the flow measurement relative to flow circuit.

1.2 How Does It Work?

The U1000MKII WM uses a cross correlation transit time algorithm to provide accurate flow measurements.

An ultrasonic beam of a given frequency is generated by applying a repetitive voltage pulse to the transducer crystals. This transmission goes first from the downstream transducer to the upstream transducer as shown in the upper half of Figure 1. The transmission is then made in the reverse direction, being sent from the upstream transducer to the downstream transducer as shown in the lower half of Figure 1. The speed at which the ultrasound is transmitted through the liquid is accelerated slightly by the velocity of the liquid through the pipe. The subsequent time difference $T1 - T2$ is directly proportional to the liquid flow velocity.

With Heat Meter models, two temperature sensors measure the difference in temperature between the flow and return of the flow system being monitored. The temperature difference, in combination with the volume of water that has flowed through the system, is then used to calculate the energy transferred to or from the water.

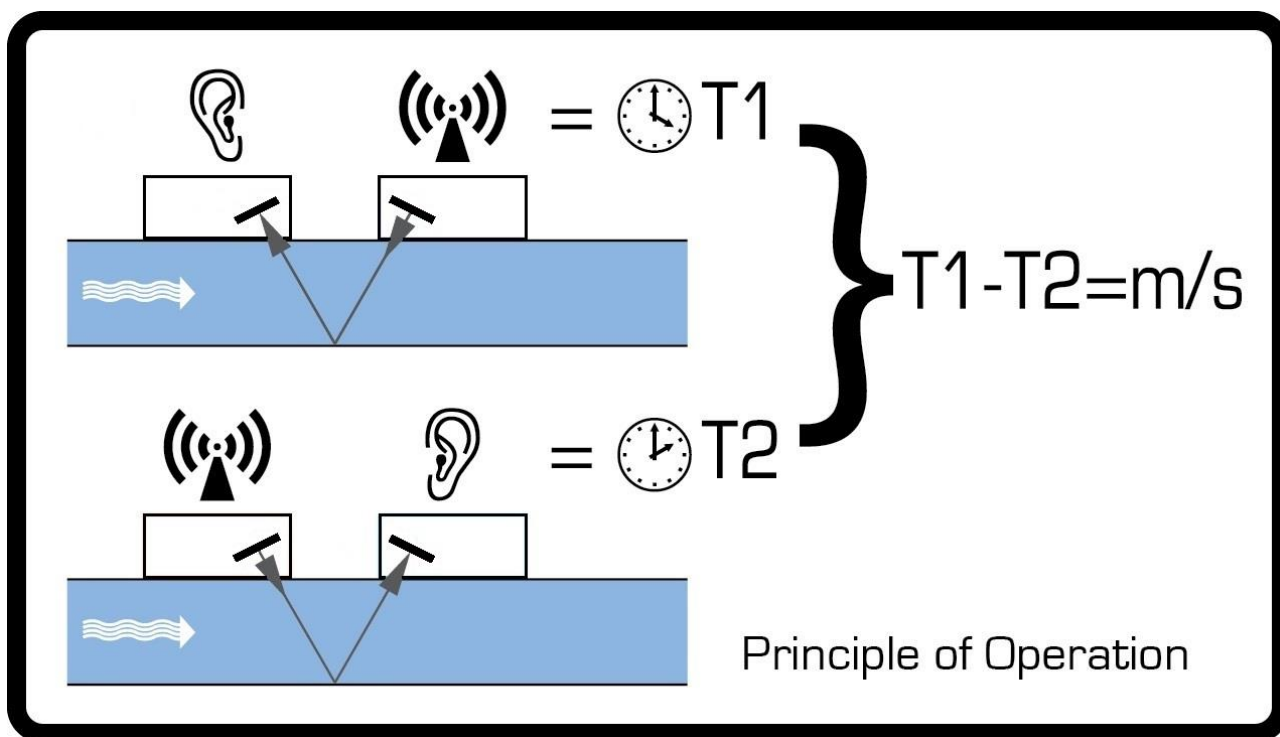

Figure 1 Principle of Transit-Time operation

1.3 Package Contents

The unit consists of:

1. **Wall-mounted electronics and control unit**
Consisting of the keypad with display, power, communications and sensor connections.
2. **Ultrasonic Flow Sensors**
Two transducers for flow measurement with VHB gel pads to ensure good contact with pipework.

In addition, the kit contains:

3. Guide rail
4. *Heat Meter versions only*: Non-releasable stainless-steel cable ties for temperature sensors and cables (4)
5. Quick release clamps for use with pipes with an OD of 25-70mm (p/n 225-5007) or 51-127mm (2) (p/n 225-5001)
6. *Heat Meter versions only*: PT100 temperature sensors with 3m cable (2)
7. 12 V power supply and adapters (optionally supplied).

The kit also contains a copy of this manual.



Figure 2 Package Contents

1.4 Display

The U1000MKII WM display comprises:

- One 2-line x 16 character LCD with backlight
- Four tactile key switches
- Two LEDs

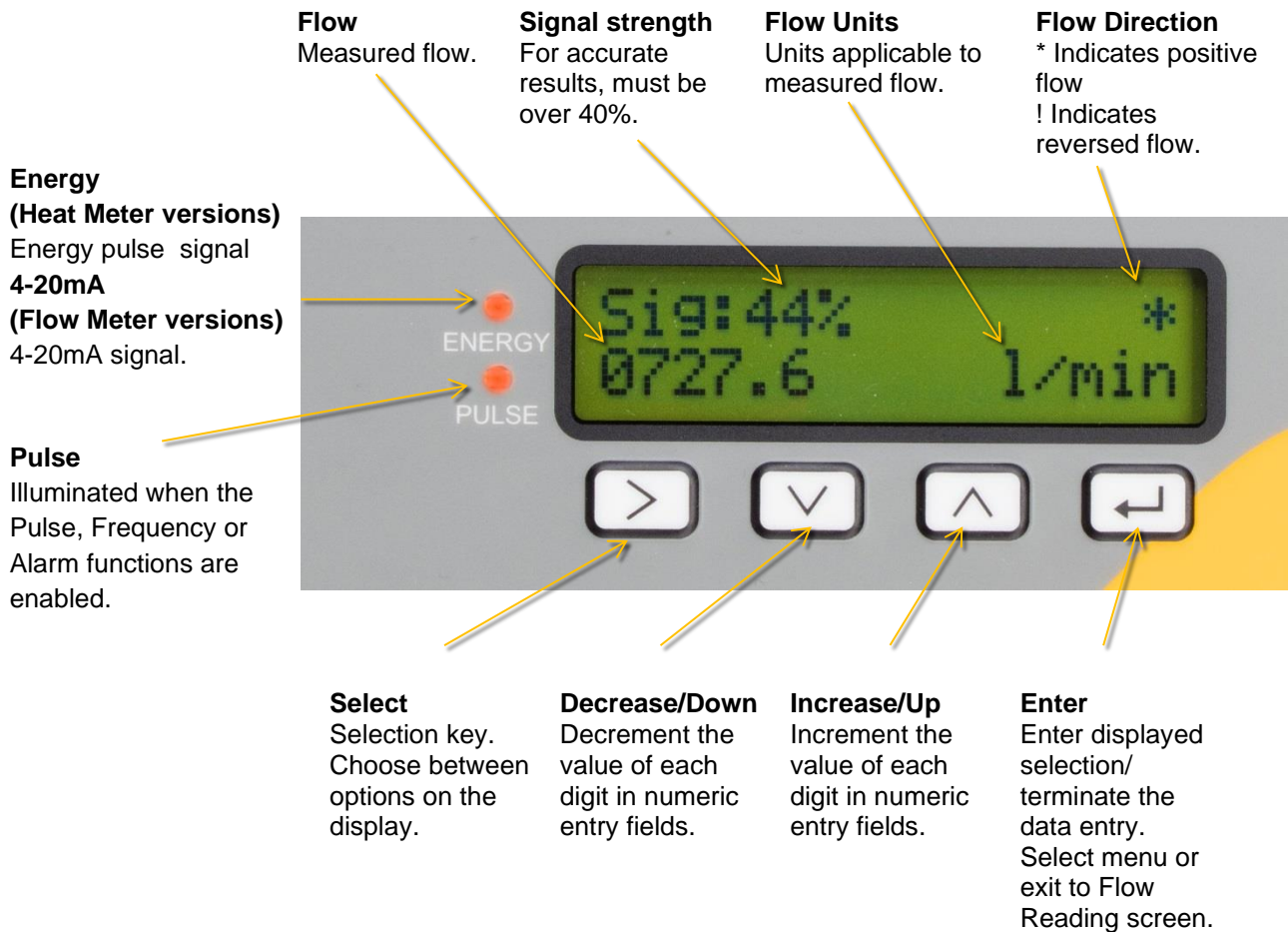

Figure 3 U1000MKII WM display (Heat Meter model shown)

1.5 Quick Start Procedure

The following procedure summarises the steps required to set up the U1000MkII WM. Please refer to the referenced sections for full details.

1. Identify a suitable location for the sensors and guide rail on a straight length of pipe clear of bends and valves or similar obstructions (See pages 7 and 43). Make a note of the pipe internal diameter, wall thickness and material at this point.
2. Connect the wall-mount electronics unit:
 - a. Fix the unit to a convenient location on a wall within 5m of the pipe location.
 - b. Connect to a 12 to 24V AC or DC power supply (7VA minimum per instrument) - See page 8.
 - c. Switch on and program to determine the correct sensor separation (See page 12).
3. Attach the flow sensors and guide rail:
 - a. Set the flow sensors to the correct separation (see page 14).
 - b. Apply the gel pads to the sensors (see page 14).
 - c. Mount the sensor and guide rail assembly onto the pipe using the supplied hose clips (see page 14).
4. Connect the sensors to the wall-mounted electronics unit (see page 8).
5. *Heat Meter versions only:* Connect the PT100 temperature sensors to the electronics unit (see Section 2.2.3, page 9) and attach to the flow and return pipes (see Section 2.1.1, page 7).
6. Check that flow readings can be obtained (see page 17).

1.6 Output and Communication Options

To use a Pulse Output option, see page 28.

To use the 4-20mA Output, see page 29.

To use the Modbus interface, see page 30. The address, data rate, and configuration of the instrument must be set using the Modbus Menu (see page 23). The default address is 1, the default data rate is 38400 baud, and the default Comms configuration is 8-None-2.

To use MBus communication, see page 33. The primary and secondary addresses must be set using the MBus Menu (see page 23).

2 INSTALLATION

2.1 Identify Suitable Location

We recommend a location where there is a straight length of pipe with no bends, constrictions or obstructions within at least 10 times the pipe diameter upstream, and 5 times the pipe diameter downstream.

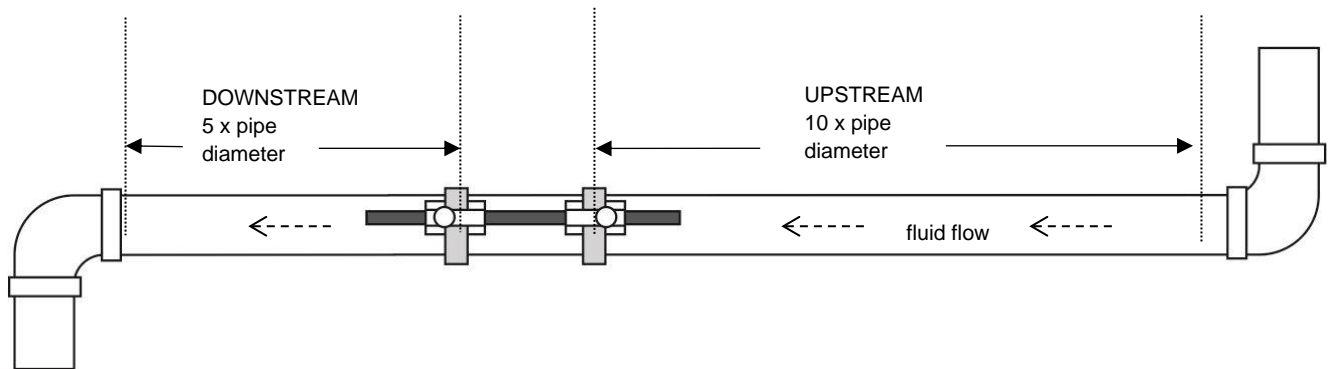

Figure 4 Identifying a suitable location

IMPORTANT: DO NOT EXPECT TO OBTAIN ACCURATE RESULTS IF THE UNIT IS POSITIONED CLOSE TO ANY OBSTRUCTION THAT DISTORTS THE UNIFORMITY OF THE FLUID FLOW PROFILE (SEE PAGE 43). MICRONICS LTD ACCEPTS NO RESPONSIBILITY OR LIABILITY IF PRODUCT HAS NOT BEEN INSTALLED IN ACCORDANCE WITH THESE INSTRUCTIONS.

2.1.1 Additional Considerations for Locating Heat Meter versions

For optimum reliability on boiler applications, the flow measurement needs to be made on the cold side of the system. For optimum reliability in chiller applications, the flow measurement needs to be made on the warmer side of the system.

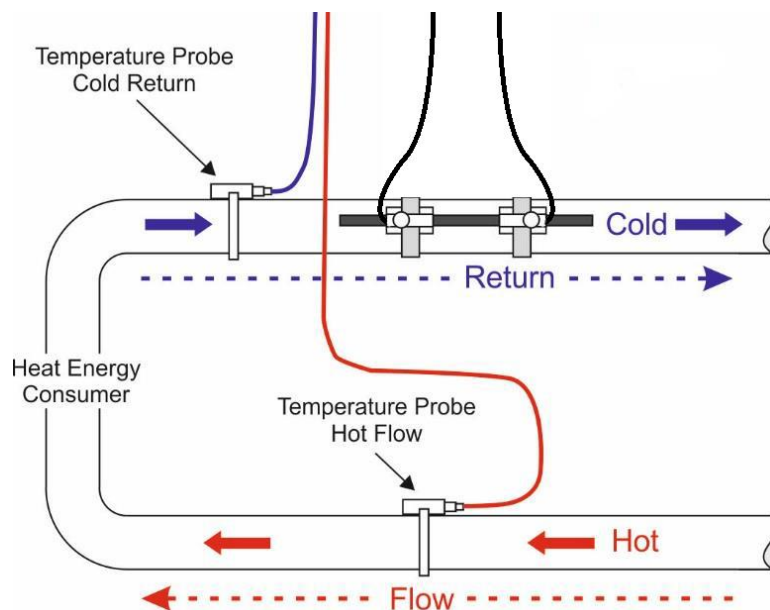

Figure 5 Typical setup of U1000MkII-WM Heat Meter for boiler applications

2.1.2 Clean the Pipe’s Flow Sensor Contact Area

Prepare the pipe by degreasing it and removing any loose material or flaking paint in order to obtain the best possible surface. A smooth contact between pipe surface and the face of the sensors is an important factor in achieving a good ultrasound signal strength and therefore maximum accuracy.

Heat Meter versions: The area of pipe where the temperature sensors are to be attached must be free of grease and any insulating material. It is recommended that any coating on the pipe is removed so that the sensor has the best possible thermal contact with the pipe.

2.2 Connect Power and Signal Cables

This section explains how to connect power and signal cables to the terminal blocks inside the wall mount unit.

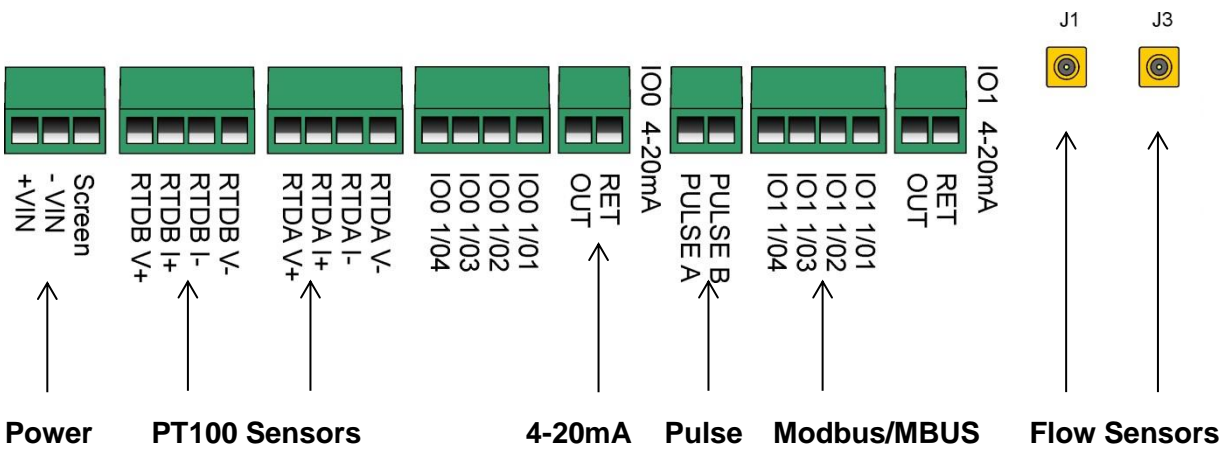

Figure 6 Terminal blocks and connectors

2.2.1 Power Supply

The U1000MKII WM will operate within the voltage range 12 - 24V AC/DC. Micronics can supply, as an optional item, a 12VAC power supply. If you intend to use an alternative power supply it must have a minimum rating of 7VA per instrument. Connect the power supply to the left-hand terminal block labelled +VIN, -VIN and Screen.

! EXTERNAL POWER SUPPLY MUST BE CLASS 2 RATED.

! IMPORTANT: IT IS THE RESPONSIBILITY OF THE INSTALLER TO CONFORM TO THE REGIONAL VOLTAGE SAFETY DIRECTIVES WHEN CONNECTING THE U1000MKII WM TO A POWER SUPPLY USING A MAINS-RATED TRANSFORMER.

2.2.2 Guiderail/Flow Sensors

Connect the flow sensors to pins J1 and J3 using the attached 5m cables.

2.2.3 PT100 Sensors (Heat Meter versions only)

Connect the two PT100 temperature sensors to the terminal blocks labelled RTDA and RTDB using the attached 4-core, 5m cables, as shown in Figure 7. Do not fasten the probes to the pipework until you have carried out the calibration (see page 15).

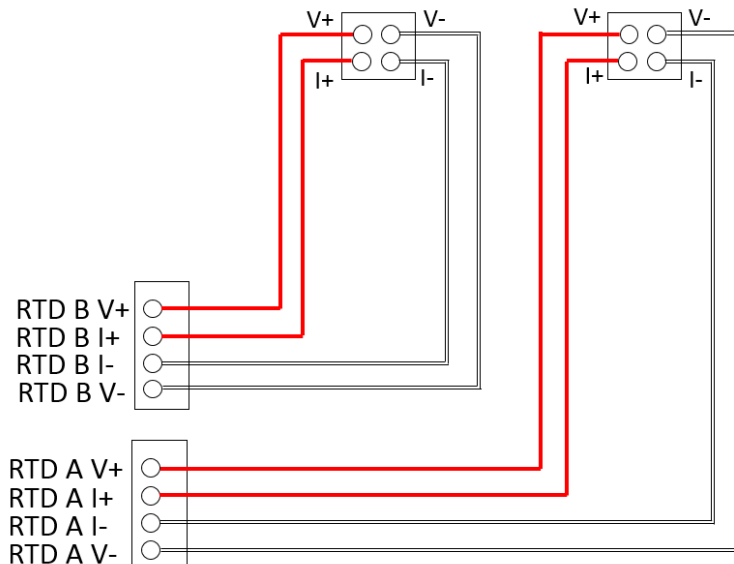

Figure 7 U1000MKII WM Heat Meter PT100 Temperature Probe Wiring

2.2.4 Pulse Output Connection

The isolated pulse output (labelled PULSE A and PULSE B) is provided by a SPNO/SPNC MOSFET relay which has a maximum load current of 500mA and maximum load voltage of 48V AC. The relay also provides 2500V isolation, between the unit's electronics and external equipment.



This output is suitable for SELV circuits only

Electrically this is a Volt, or potential free contact and, when selected as a low flow alarm, is configurable NO/NC.

2.2.5 Current Output (if fitted)

U1000MkII WM unit can be optionally configured with a 4-20mA output. The isolated 4-20mA is a current source and can drive into a maximum load of 620Ω.

If fitted, the 4-20mA current outputs are available at the terminal block labelled IO0 4-20mA with RET and OUT connections. The alarm current due to a flow outside the range specified or due to a loss of signal is set at 3.5mA.



This output is suitable for SELV circuits only

2.2.6 Modbus/MBUS Connections (if fitted)

If fitted, the Modbus or MBUS output is available at the terminal blocks labelled IO1 1/01-04 terminals:

IO1 Terminal	Modbus	MBUS
IO4	ISOL_GND	ISOL_GND
IO3	OUT_A	BUS1_IN
IO2	ISOL_GND	ISOL_GND
IO1	OUT_B	BUS2_IN

For reliable operation of a Modbus network the cable type and installation must comply with requirements in the Modbus specification document:

“MODBUS over Serial Line Specification & Implementation guide V1.0”:

https://modbus.org/docs/Modbus_over_serial_line_V1.pdf

For full immunity to electrical interference the screen of the power/pulse output cable and Modbus cable should be connected to Earth.

For reliable operation of an M-bus network the cable type and installation must comply with requirements in the M-bus specification document:

“Meter Communication Twisted Pair Baseband (M-Bus) Physical and Link Layer”:

<https://m-bus.com/assets/downloads/MBDOC48.PDF>

 **This output is suitable for SELV circuits only**

For full immunity to electrical interference the screen of the power/pulse output cable and Modbus cable should be connected to Earth.

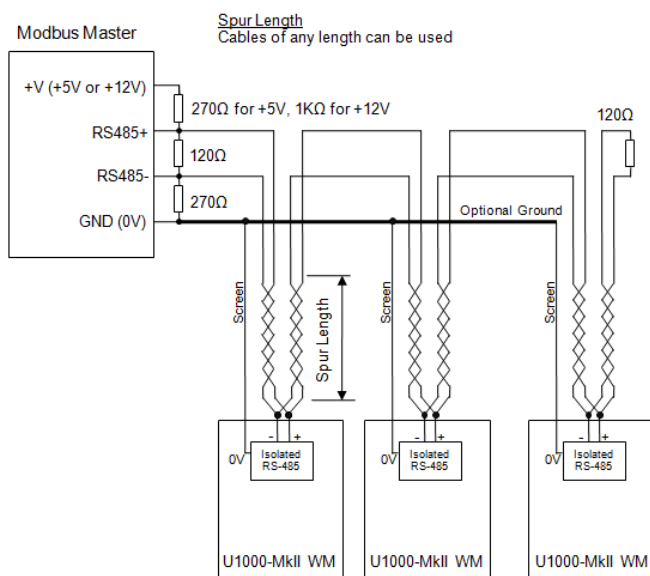

Figure 8 Modbus wiring diagram with spurs

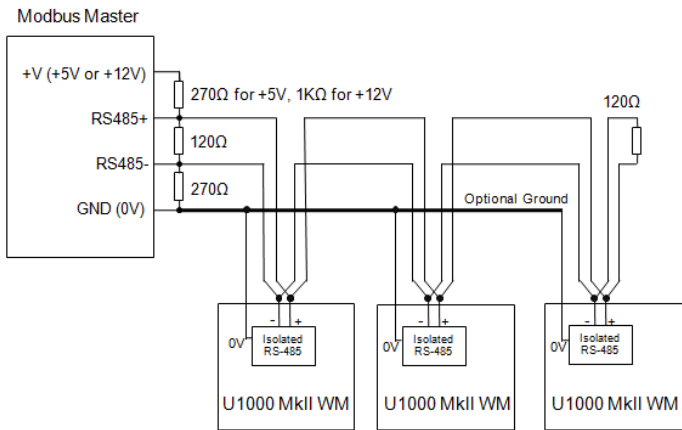

Figure 9 Modbus wiring without spurs

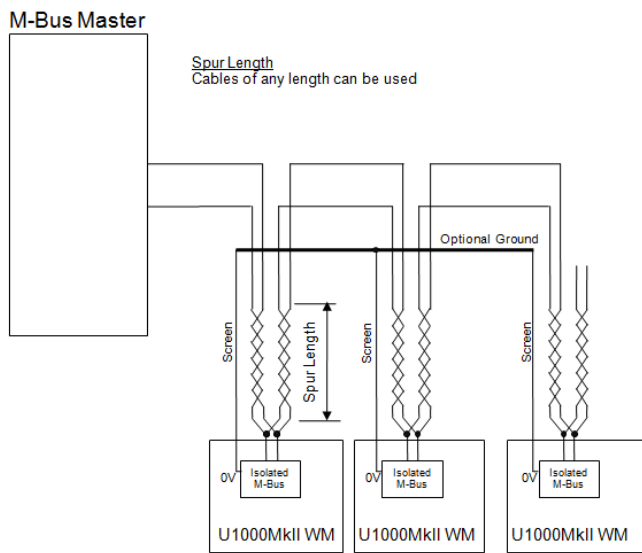

Figure 10 M-Bus wiring with spurs

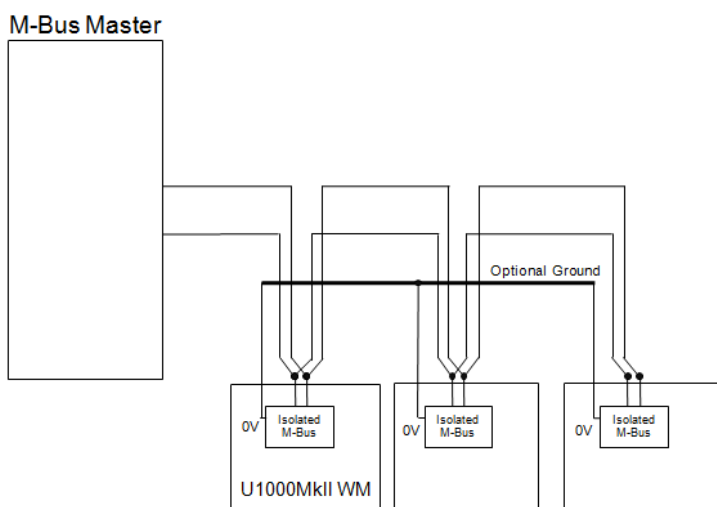

Figure 11 M-Bus wiring without spurs



2.3 Switch On

The initial screen sequence is different for the Flow Meter and Heat Meter models.

2.3.1 U1000MKII WM Flow Meter

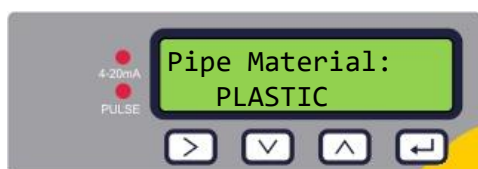
Switch on the power to the Electronics Module. A Micronics start-up screen is displayed for 5 seconds followed by hardware and software version information.



Select the pipe material by using the  and  keys to scroll through the list.

Press  to confirm the material.

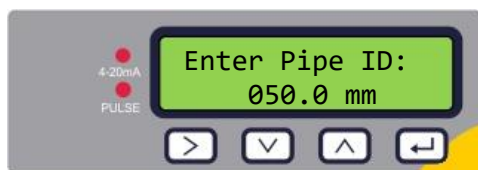

You are then prompted to enter the internal diameter of the pipe:

Use the ,  and  keys to change the value.

Press  to confirm the value.

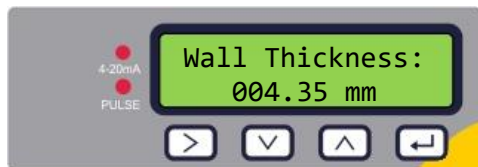

Enter the wall thickness of the pipe:

Use the ,  and  keys to change the value.

Press  to confirm the value.

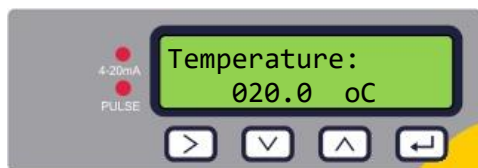

Enter the temperature of the fluid. The value must be in the range 0.1 – 140.0°C.

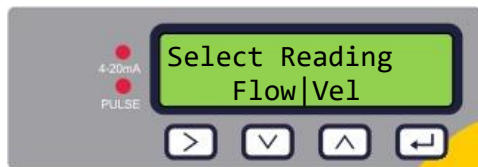

Select to read Flow or Velocity using the  key.

Press  to confirm the selection.

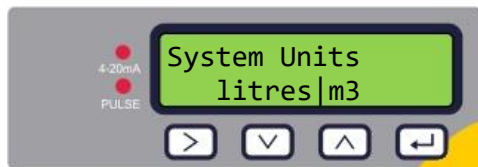

Select the System Units using the  key.

Press  to confirm the System Units.

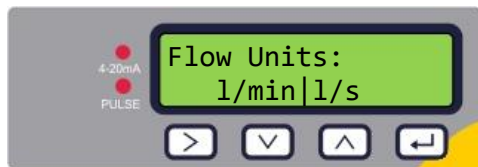

Select the Flow Units using the  key.

Press  to confirm the Flow Units.

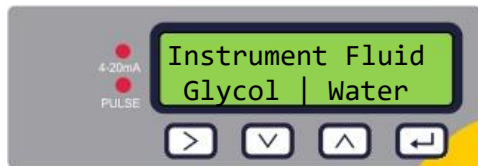

Select the fluid using the  key.

Press  to confirm the fluid name.



The unit now shows the correct flow sensor separation (in this case, "12.4mm") for the chosen values of pipe ID, pipe material and fluid.

Make a note of the separation distance.



All subsequent start-ups will use the same configuration. If the configuration needs to be changed for any reason, use the password-controlled menu (see page 19).

Continue with the installation of the Sensor Assembly (see page 14).

2.3.2 U1000MKII WM Heat Meter

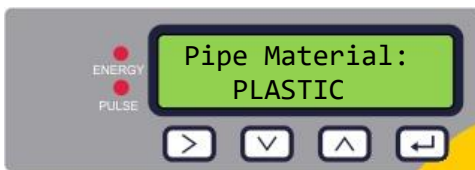
Switch on the power to the Electronics Module. A Micronics start-up screen is displayed for 5 seconds followed by hardware and software version information.



Select the pipe material by using the  and  keys to scroll through the list.

Press  to confirm the material.

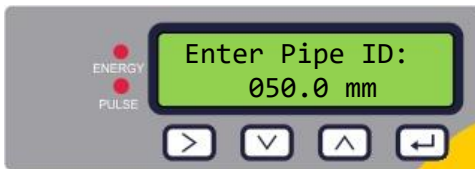

You are then prompted to enter the internal diameter of the pipe:

Use the ,  and  keys to change the value.

Press  to confirm the value.

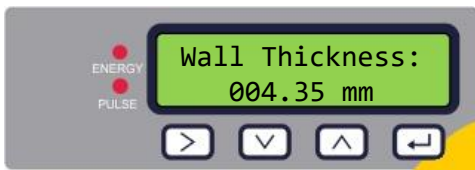

Enter the wall thickness of the pipe:

Use the ,  and  keys to change the value.

Press  to confirm the value.

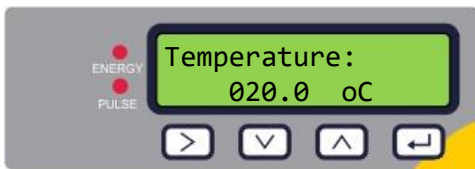

Enter the temperature of the fluid. The value must be in the range 0.1 – 140.0°C.

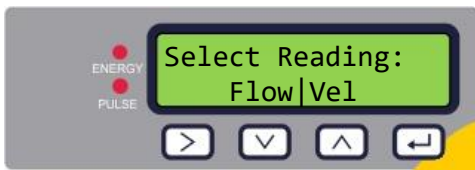

Select to read Flow or Velocity using the  key.

Press  to confirm the selection.

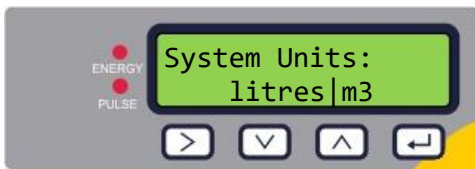

Select the System Units using the  key.

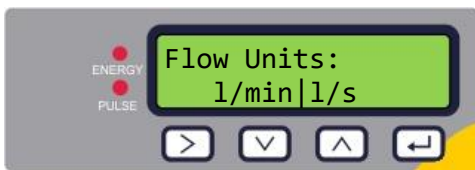

Press  to confirm the System Units.



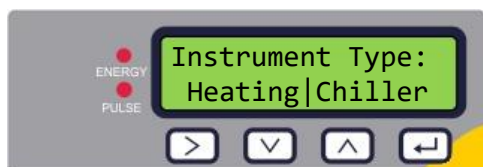

Select the Flow Units using the  key.

Press  to confirm the Flow Units.

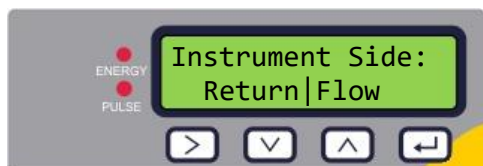

Select the Instrument Type using .
The unit is preconfigured for Heating applications.
Press  to confirm the setting.



Select the Instrument Side (where flow sensors are installed) using .
The unit is preconfigured for *Flow*.
Press  to confirm the setting.

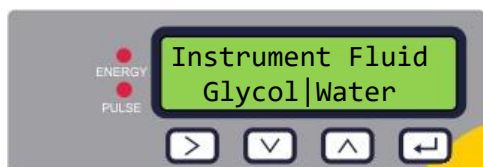

Select the fluid using .
Press  to confirm the fluid name.

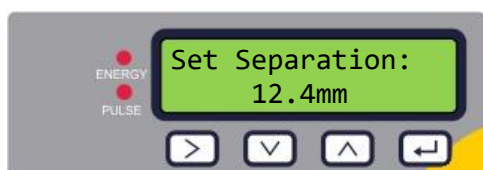

The unit now shows the correct flow sensor separation (in this case, "12.4mm") for the chosen values of pipe ID, pipe material and fluid.

Make a note of the separation distance.

All subsequent start-ups will use the same configuration. If the configuration needs to be changed for any reason, use the password-controlled menu (see page 19).

Continue with the installation of the Sensor Assembly.

2.4 Assemble the Guiderail

Slide the guiderail through the slot on the top of the two transducers.

(Note: the cables should be on the outside edges of the assembly)

2.5 Adjust Flow Sensor Separation

Using the separation distance displayed by the control unit (see page 12), adjust the transducer separation accordingly. Fasten the sensors to the correct position on the guiderail using the thumbscrews.

2.6 Apply Gel Pads

1. Apply a gel pad centrally onto the bases of each of the two flow transducers.
2. Remove the covers from the gel pads.
3. Ensure there are no air bubbles between each pad and sensor base.

2.7 Clamp Guiderail to Pipe

Ensure that you have selected a suitable location (see pages 7 and 43) and that the pipe is clean (see page 8).

Using the quick-release clamps provided, fasten the transducers to the pipe at an angle of 45° as shown in Figure 12. Experience has shown that the most consistently accurate results are achieved when the unit is mounted at this angle (see page 43). This minimises the effect of any flow turbulence resulting from entrained air along the top of the pipe and sludge at the bottom.

2.8 Calibrate the PT100 Sensors (Heat Meter versions only)

IMPORTANT: THE PT100 SENSORS MUST BE BALANCED BEFORE INITIAL USE, USING THE PROCEDURE DESCRIBED BELOW AND USED WITH THE CABLE LENGTH SUPPLIED. EXTENDING OR SHORTENING THE CABLES WILL NEGATE THE CALIBRATION OF THE SENSORS.

To ensure an accurate temperature differential:

1. Place the PT100 sensors touching each other and allow their temperature to stabilise for 1 minute.
2. Enter the password controlled menu and scroll to the *Calibration* sub-menu (see page 19).
3. Press the Enter key until the *Zero Temp Offset* screen is displayed (see page 26).
4. Select **Yes** and press the Enter key to display the *Attach Sensors* screen.
5. Press the Enter key again and wait for instrument to return to the *Zero Temp Offset* screen.

2.9 Attach the PT100 Sensors (Heat Meter versions only)

The PT100 sensors must be located at the input and output of the system that is being monitored. The area of pipe where they are to be attached must be free of grease and any insulating material. It is recommended that any coating on the pipe is removed so that the sensor has the best possible thermal contact with the pipe.

Clamp the sensors in position using the supplied stainless-steel cable ties.

(Note: be careful not to excessively pull on the cables as this will damage the sensor, secure the cable to the pipe with the provided stainless steel cable ties to prevent strain on the cable interface)



Figure 12 Fully assembled U1000MKII-WM Heat Meter unit

2.10 Normal Operation

The screen sequence is different for the Flow Meter and Heat Meter models.

2.10.1 U1000MKII-WM Flow Meter

Press .

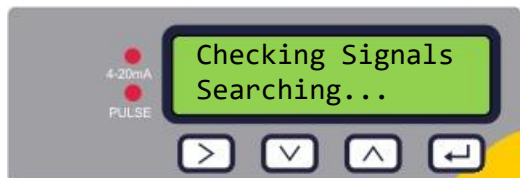

The unit checks for a valid flow signal.



If a valid signal is found, signal strength and flow rate are displayed. The signal strength should be at least 40% for reliable operation.

2.10.2 U1000MkII-WM Heat Meter

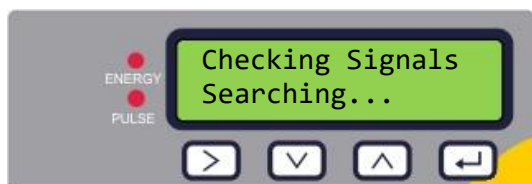

Press .

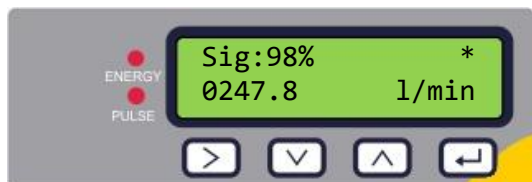

The unit checks for a valid flow signal.



If a valid signal is found, signal strength and flow rate are displayed. The signal strength should be at least 40% for reliable operation.

Press the  and  keys to scroll to the *Total Flow*, *Temperature dT*, *Total Energy* and *Instant Power* screens.

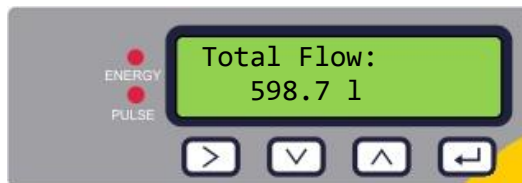
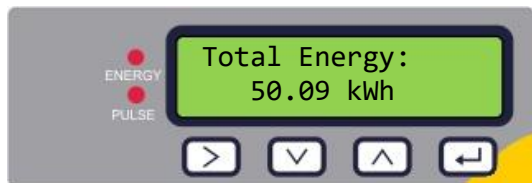
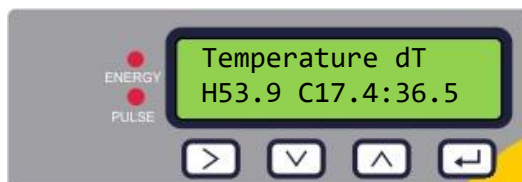
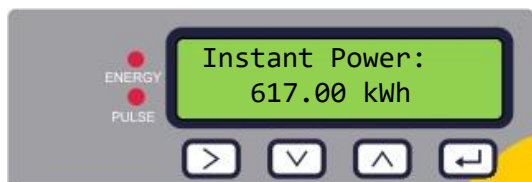

2.10.3 Troubleshooting the Flow Reading

The direction of flow when powered up will be taken to be the positive flow direction. The pulse output will relate to the flow in this direction. If the flow is reversed then the flow rate will still be displayed but the activity indication will change from an asterisk to an exclamation mark and no pulses will be generated.

If the flow value is displayed as "----" this indicates that there is no usable signal from the flow sensors.

The cause of this could be:

- Incorrect pipe data
- Sensor not in contact with the pipe
- Air in the liquid/pipe
- No Gel pad or grease on the sensor
- Very poor pipe condition-surface/inside

3 MENUS

The password-protected menus allow you to change the default settings:

- Setup (see page 21)
- Current Output (see page 22) – *if 4-20mA output option installed*
- Modbus (see page 23) – *if Modbus output option installed*
- M-Bus (see page 23) – *if M-Bus output option installed*
- Pulse Output (see page 24)
- Calibration (see page 26)
- Volume Totals (see page 26)
- Exit

For troubleshooting purposes, an additional Diagnostics menu is available from the main *Flow Reading* or *Total Flows* screens (see page 27).

3.1 Accessing the Menus

Ensure that the instrument is in *Flow Reading*, *Total Flow*, *Temperature dT*, *Total Energy*, *Instant Power* or *Total Flow* modes, then press .

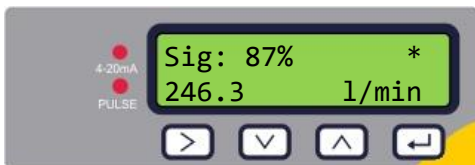



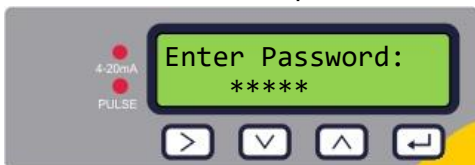

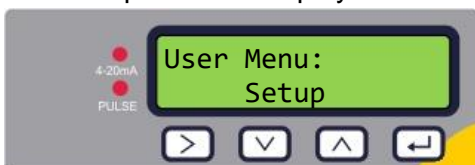

Enter 71360 and then press .



The Setup Menu is displayed.



Use  and  to cycle through the menu sections. Press  to open a menu. To return to the Flow Reading screen, scroll down to **Exit** and press .



Within a menu, press  to change between two displayed options (the active setting flashes) or, if there are several options, use  and  to cycle through the possible values.

Press  to confirm a value and display the next setting (or exit the menu if it is the last option).

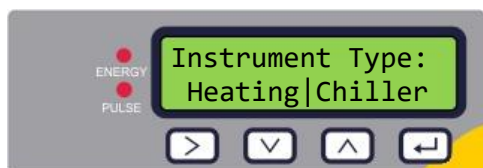
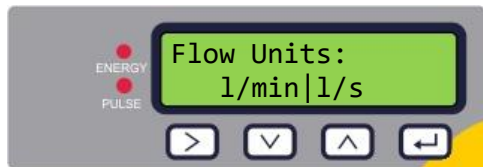
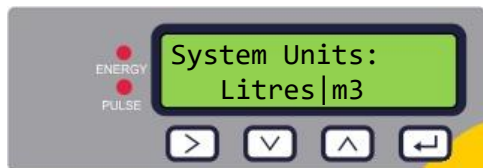
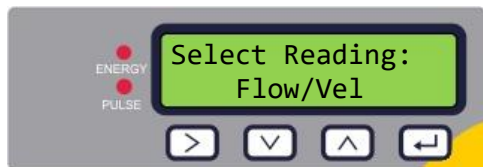
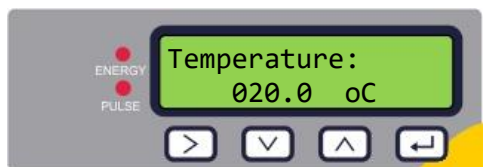
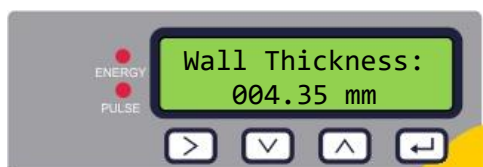
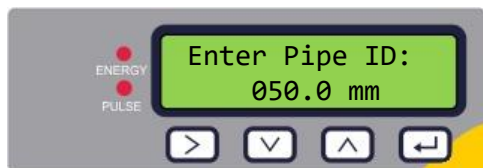
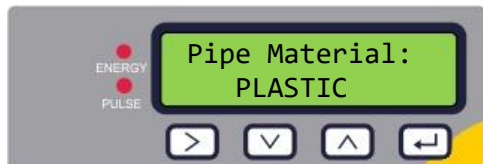
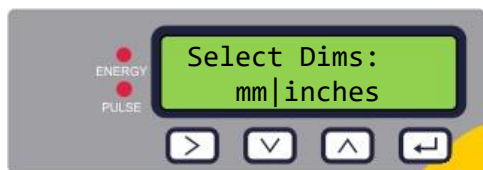
3.2 Setup Menu



Choose whether to use imperial or metric units (default). If “inches” option is selected, the temperatures will be displayed in °F and the energy values will be in BTUs. The following diagrams show the metric options only.

Select the pipe material by using the  and  keys to scroll through the list.

Press  to confirm the material.

You are then prompted to enter the internal diameter of the pipe:

Use the ,  and  keys to change the value.

Press  to confirm the value. Depending on configuration of the unit, valid values are in the range : 20 -110mm (0.787– 4.33 inches) or 100 – 220mm (3.94 – 8.66 inches).

Enter the wall thickness of the pipe:

Use the ,  and  keys to change the value.

Press  to confirm the value.

Enter the temperature of the fluid. The value must be in the range 0.1 – 140.0°C.

Choose the default display option: *Flow* (flow rate, for example, l/min) or *Vel* (velocity, for example, m/s).

Choose the **System Units**. If you selected **mm** in the first step (*Select Dim*), the choice is litres or m³. If you selected **Inches**, the choice is Imperial gallons or US gallons.

Choose the **Flow Units**. If you selected **mm** in the first step (*Select Dims*), the choice is l/min or l/s. If you selected **Inches**, the choice is gal/min or gal/hr (with either Imperial or US gallons according to the *System Units* selection).

Heat Meters only

Select the instrument setting using .

The unit is preconfigured for Heating applications.

Press  to confirm the setting.

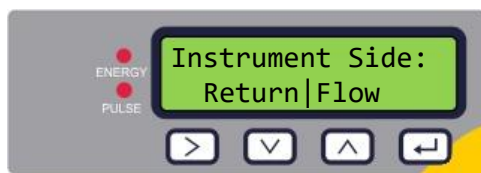
**Heat Meters only**

Select the Instrument Side (where flow sensors are installed) using .

The unit is preconfigured for *Flow*.

Press  to confirm the setting.

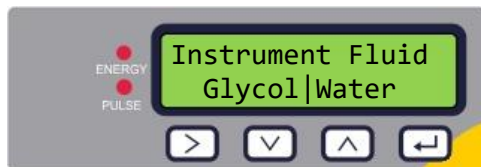

Select the fluid using .

Press  to confirm the fluid name.

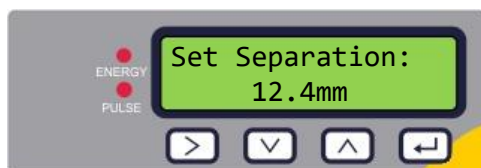



The unit now shows the correct flow sensor separation (in this case, "12.4mm") for the chosen values of pipe ID, pipe material and fluid.

Make a note of the separation distance.

Press  to return to the Main Menu.

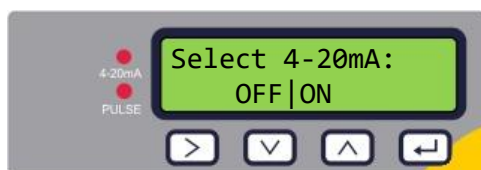
3.3 Current Output Menu (4-20mA versions only)



Enable or disable the 4-20mA output using  to select OFF or ON.

Press  to confirm the setting.

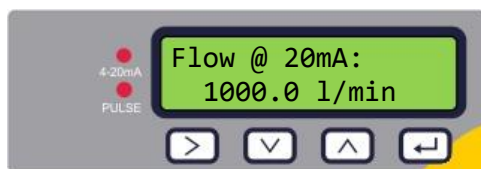

Enter the maximum flow.

Press  to confirm.

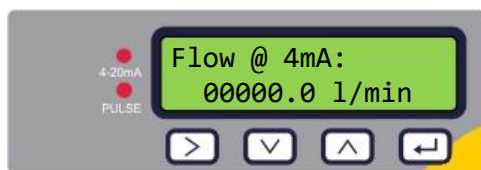

Enter the minimum flow.

Press  to confirm.

Press  to return to the Main Menu.

3.4 Modbus Setup Menu (Modbus versions only)

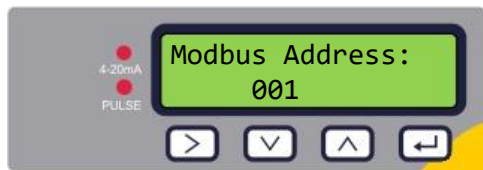

Enter the Modbus Address for this unit. The valid range is 1 to 126.

Press  to confirm the setting.

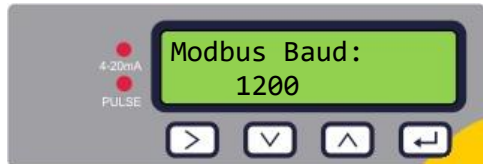

Enter the baud rate for the Modbus network. Valid settings are 1200, 2400, 4800, 9600, 19200, or 38400.

Press  to confirm.



Select the Modbus data format. Valid settings are 8-None-2, 8-Even-1, 8-Odd-1, 8-None-1. The settings relate to the number of data bits in each character (8), the parity (Odd, Even or none), and the number of stop bits (1 or 2).

Press  to confirm.

Press  to return to the Main Menu.

3.5 M-Bus Setup Menu (M-Bus versions only)

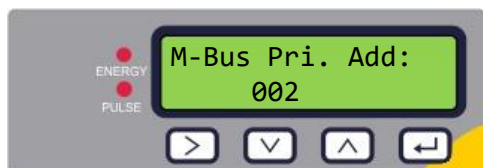

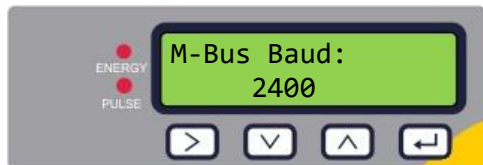

Enter the M-Bus Primary Address for this unit. The valid range is 0 to 250.

Press  to confirm the setting.



Enter the M-Bus Baud rate for this unit. The valid options are 300, 2400 or 9600 Baud.

Press  to confirm the setting.

Press  to return to the Main Menu.

3.6 Pulse Output Menu

All models allow the use of a pulse output based on Volume pulse, Alarm, Energy pulse (Heat Meter versions only) or Frequency indicating flow rate.

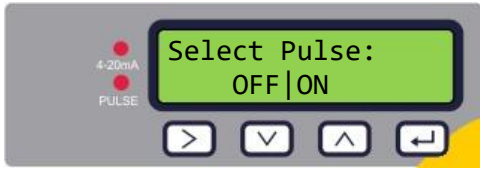

Enable or disable the Pulse output using  to select OFF or ON.

Press  to confirm the setting.

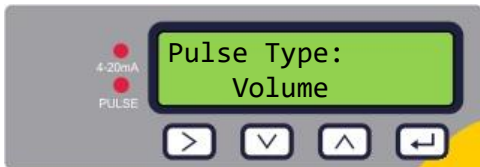

Choose the Pulse type: Volume, Flow Alarm, Energy (Heat Meter versions only), or Frequency.

Press  to confirm.

3.6.1 Volume Pulse

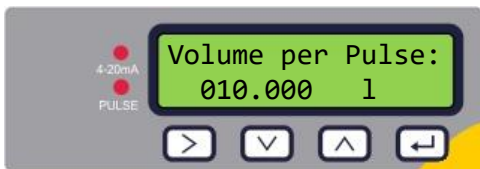

Set the Volume per Pulse so that the maximum number of pulses does not exceed 10 per second or 1000ms (see page 28).

Press  to confirm the setting.

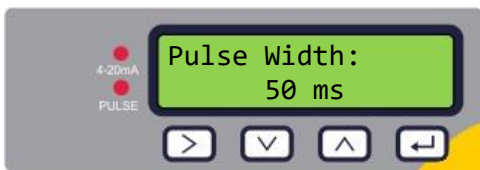

Set the Pulse Width. The default value is 50ms which represents half of one pulse cycle. A 50ms pulse width is required for most mechanical counters.

Press  to confirm the setting.

Press  to return to the Main Menu.

3.6.2 Flow Alarm



Choose the type of alarm: **Level**, triggering at a lowest acceptable flow rate, or **Signal Loss**, indicating a loss or malfunction of flow or signal.

Press  to confirm the setting.

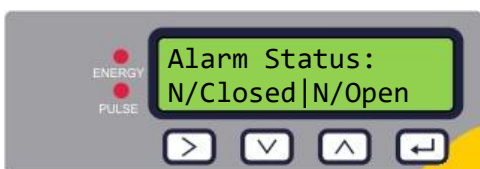

Select the status of the pulse output during normal operation: **Normally Closed** or **Normally Open**.

Press  to confirm the setting.



Only displayed if *Level* Type alarm type has been selected. Enter the flow value required to trigger the alarm.

Press  to confirm the setting.

Press  to return to the Main Menu.

3.6.3 Energy Pulse (Heat Meter versions only)

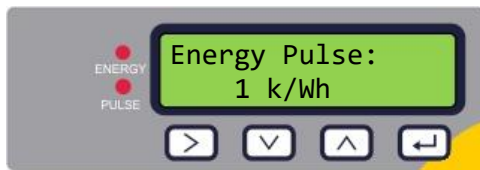

Choose from 1,10,100kWh or 1MWh when in metric mode and 1,10,100kBTU or 1MBTU in imperial mode. Each pulse represents the selected amount of energy e.g. 1kWh. Choose a value so that the pulse rate does not exceed 10 per second (see page 29).

Press  to confirm the setting.

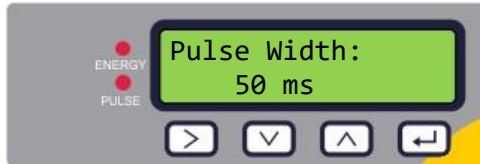

Set the Pulse Width. The default value is 50ms which represents half of one pulse cycle. A 50ms pulse width is required for most mechanical counters.

Press  to confirm the setting.

Press  to return to the Main Menu.

3.6.4 Frequency

In Frequency mode, the pulse output frequency is proportional to the flow rate within a specified frequency range of 1 – 200Hz.

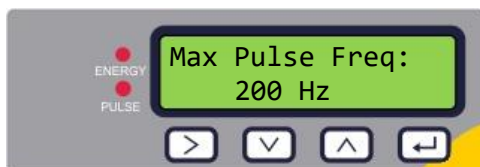

Choose the Maximum Pulse Frequency. The valid range is 1.0 – 200.0 Hz.

Press  to confirm the setting.

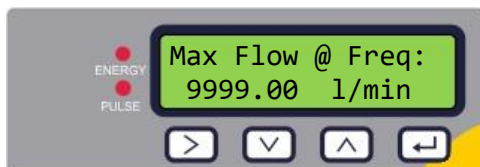

Enter the maximum flow rate at the specified frequency. **The flow units are fixed as litres per second.**

Press  to confirm the setting.

Press  to return to the Main Menu.

3.7 Calibration Menu



Choose a Damping Time of 10, 20, 30, 50 or 100s.

Press to confirm the setting.

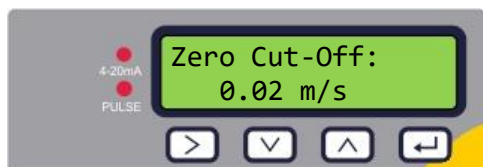

Set the Zero Cut-Off value (in the range 0.00 – 0.50 m/s).

Press to confirm the setting.

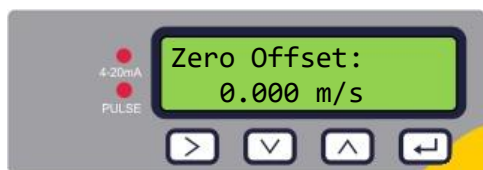

Press to calculate the Zero Offset automatically.

NOTE: SET 'ZERO CUT-OFF' TO ZERO BEFORE SETTING 'ZERO OFFSET' THEN GO BACK TO SET 'ZERO CUT-OFF'.

Press to confirm the setting.

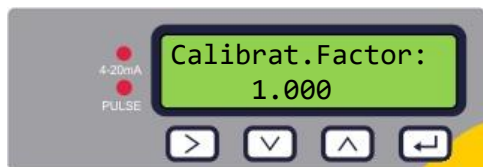

Enter a calibration factor (valid range 0.500 – 1.500).

Press to confirm the setting and, in the case of Flow Meter versions, return to the Main Menu.

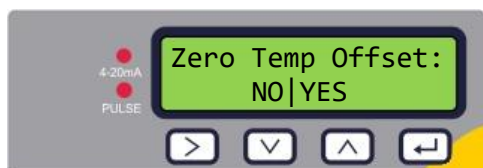

Heat Meter versions only.

Select YES to calculate the Zero Temperature Offset value. Select NO to return to the Main Menu.



You are prompted to attach the sensors. Place the PT100 sensors touching each other and allow their temperature to stabilise for 1 minute.

Press to continue.

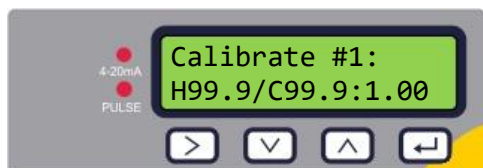

The unit calculates the temperature offset.

When the procedure is complete, the **Zero Temp Offset** screen is displayed with NO selected.

Press to return to the Main Menu.



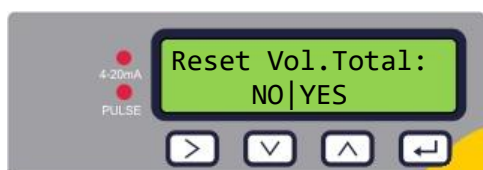

3.8 Volume Totals Menu



To zero the Volume Totals value, select Yes.

Press to confirm the action and return to the Main Menu.

3.9 Diagnostics Menu

The diagnostics menu provides some additional information about the flowmeter and its setup. The menu can be accessed by pressing the  key from the main flow-reading screen. Press the  and  keys to move between the diagnostics screens. Press  to exit the Diagnostics menu.

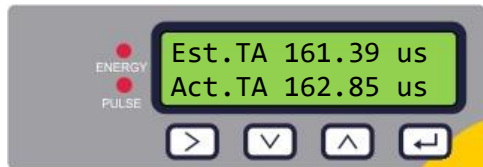

The Estimated TA (Time of Arrival) and Actual TA show the theoretical and measured transit times. If the actual value is displayed as 9999.99 then a usable signal could not be detected..



Displays the pulse status (for example): Deactivated, Volume 0.000 litres, Signal Loss, Alarm(On) 500.0 l/min, Alarm(Off) Signal Loss, Frequency 100.00 Hz.

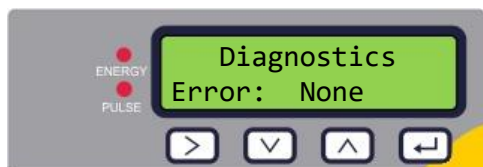

This screen will display the Errors. A number between 0-255 will be displayed. If no errors reported "None" is displayed.



The RTD board's firmware version is shown on the lower line. The upper line shows its status.



The flow board's firmware version is shown on the lower line. The upper line shows its status.

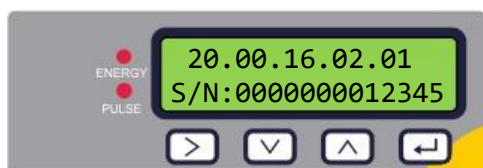

The unit's firmware version is shown on the upper line. The lower line shows the unit's serial number.

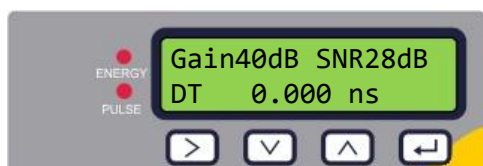

Gain – a decibel number between -5dB and 80dB – *lower is better*, should be around 40dB or below. Above 60dB need to question the installation.

SNR (Signal/Noise ratio) in dB, scale is 0 to 80dB – *higher is better*. Below 20, question the installation.

The lower line shows the current time differential between the upstream and downstream signals.

4 OUTPUTS

4.1 Pulse Output

Pulse output can be set up to operate one of five modes:

- Volumetric flow total
- Energy (Heat Meter versions only)
- Frequency
- Low Flow Alarm
- Loss of Flow Signal Alarm

The Alarm functions allow you to set the alarm switch to *Normally Open* or *Normally Closed*.

4.1.1 Volumetric Pulse

The U1000MKII WM default pulse width is set to 50ms which represents half of one pulse cycle. A 50ms pulse width is required for most mechanical counters.

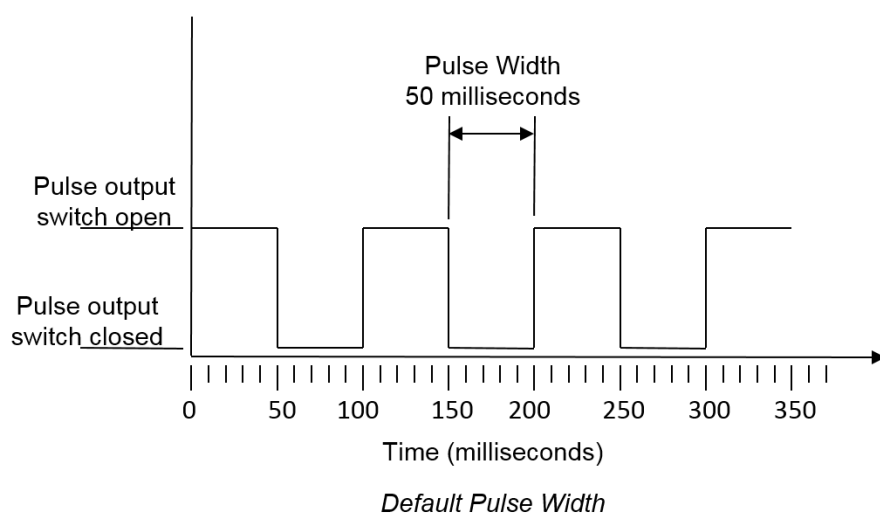

Formula to obtain Volume per Pulse based on a (default) 50ms pulse width:

Volume per Pulse \geq maximum flow rate (in litres per minute) / 600

Example for maximum flow rate of 500 l/min:

Volume per Pulse \geq 500 l/min / 600 = 0.833 litres per pulse

Rounding up to nearest whole litre:

Set **Volume per Pulse** to **1 litre**.

4.1.2 Frequency Mode

In Frequency mode, the output frequency is proportional to the flow rate within a specified frequency range of 1 – 200Hz. **The flow units are fixed as litres per second.**

4.1.3 Energy Pulse (Heat Meter versions only)

When the *Pulse Output* is set to **Energy**, the kWh LED will be permanently illuminated. Choose from 1,10,100kWh or 1MWh when in metric mode and 1,10,100kBTU or 1MBTU in imperial mode. Each pulse represents an amount of energy e.g. 1kWh. The same limitation on maximum pulse rate applies as detailed in the Volumetric Mode. Again a larger unit of energy per pulse or a smaller pulse width may be required.

4.1.4 Flow Alarm - Low Flow

For the Low Alarm the user can set a range between 0 and 9999 (no decimal places), in the same units being used to measure flow. The default setting is normally open, but the user can select between N/O and N/C. There is a 2.5% hysteresis on the switching of the output. Once the low flow alarm is activated, the flow rate must rise by 2.5% more than the set value to deactivate the alarm again.

4.1.5 Flow Alarm - Signal Loss

If the flow reading (signal) is lost, as indicated by the flow rate being displayed as "-----", the alarm will be triggered. The default setting is normally open, but the user can select between N/O and N/C.

4.2 4-20mA Current Output

The default 4-20mA output setting is OFF, and the 4-20mA LED on the keypad will not be illuminated. The default flow for 20mA output will be automatically set depending on the pipe size. The default flow for 4mA is 0. This can be changed, see page 23.

If the flow reading is greater than that set as the 20mA value, or there is negative flow, or no flow signal can be detected, then an alarm current of 3.5mA will generated.

(NOTE: THE 4-20MA CURRENT OUTPUT IS FACTORY CALIBRATED)

4.3 Modbus (if fitted)

The Modbus RTU interface is configured via the Modbus sub menu.

- Float byte order –AB CD – Big endian – MSB first.
- The data rate can be selected in the range 1200 to 38400 baud.
- The address can be set in the range 1 to 126.
- Minimum Polling Rate 1000ms (1sec). Time out after 5 seconds.
- The U1000 MKII WM will only respond to Modbus requests while operational, while the flow reading, volume total, energy total, power or temperature screens are displayed.
- The instrument responds to the “read holding registers” request (CMD 03).
- If the flow reading is invalid then the flow value will be zero.
- If a temperature sensor goes out of range then the value will go to -11°C (12.2°F).

The above faults will set the relevant status bit (see page 45).

On a unit set to *Imperial* the temperature is in °F, Power is in BTU/s and flow in US Gallons/minute.

The following registers are available.

Modbus Register	Register Offset	Type	Typical Contents	Meaning	Notes
n/a	n/a	Byte	0x01	Instrument Address	
n/a	n/a	Byte	0x03	Instrument Command	
n/a	n/a	Byte	0x40	Number of bytes to read	
40001	0	Int-16	0x00	Device ID	0xAC
			0xac		
40002	1	Int-16	0x00	Status	0x0000 OK Not[0x0000] Fault
			0x00		
40003	2	Int-16	0x00	System Type Heat Meter versions only	0x04 Heating system 0x0C Chiller system
			0x04		
40004	3	Int-16	0x00	Serial Identifier	
			0x01		
40005	4	Int-16	0x23		
			0x45		
40006	5	Int-16	0x60	Measured Velocity	Units in m/s
			0x00		
40007	6	IEEE754 float	0x40		
			0x1f		
40008	7		0x67		
			0xd3		
40009	8	IEEE754 float	0x41	Measured Flow	Units in m ³ /hr for Metric Units in US Gal/m for Imperial
			0x8c		
40010	9		0xd8		
			0xb0		
40011	10	IEEE754 float	0x42	Calculated Power (Heat Meter versions only)	Units in kW for Metric Units in BTU/s for Imperial
			0x1c		
40012	11		0x2e		
			0x34		
40013	12	IEEE754 float	0x44	Calculated Energy (Heat Meter versions only)	Units in kWh for Metric Units in BTU for Imperial
			0x93		
40014	13		0xc6		
			0xe8		

(continued)

Modbus Register	Register Offset	Type	Typical Contents	Meaning	Notes
40015	14	IEEE754 float	0x41	Measured Temperature (Hot) (Heat Meter versions only)	Units in Degrees Celsius for Metric Units in Degrees Fahrenheit for Imperial
40016	15		0x98		
40017	16	IEEE754 float	0x00	Measured Temperature (Cold) (Heat Meter versions only)	Units in Degrees Celsius for Metric Units in Degrees Fahrenheit for Imperial
40018	17		0x00		
40019	18	IEEE754 float	0x40	Measured Temperature (Difference) (Heat Meter versions only)	Units in Degrees Celsius for Metric Units in Degrees Fahrenheit for Imperial
40020	19		0x00		
40021	20	IEEE754 float	0x00	Measured Volume Total	Units in m ³ for Metric Units in US Gal for Imperial
40022	21		0x00		
40023	22	Int-16	0x60	Instrument Units	0x00 Metric 0x01 Imperial
40024	23	Int-16	0xef	Instrument Gain	Gain in dB
40025	24	Int-16	0x3c	Instrument SNR	SNR in dB
40026	25	Int-16	0x1c	Instrument Signal	Signal in %
40027	26	IEEE754 float	0x00	Measured Delta-Time Difference	Diagnostic Data Units in nanoseconds
40028	27		0x0a		
40029	28	IEEE754 float	0x00	Instrument ETA	Diagnostic Data Units in microseconds
40030	29		0x62		
40031	30	IEEE754 float	0x42	Instrument ATA	Diagnostic Data Units in microseconds
40032	31		0xc9		
n/a	n/a	Int-16	0xff	CRC-16	
			0x7d		
			0x42		
			0xa8		
			0x8b		
			0xf5		
			0x42		
			0xc8		
			0x00		
			0x00		
			0xed		
			0x98		

4.4 M-Bus (if fitted)

After power-up, the unit defaults to the baud rate and primary address set in the M-bus Menu (see page 23). Both the baud rate and primary address may be changed later over the M-Bus network. The secondary address is the unit serial number padded with two zeros.

Characters are configured as 8 data bits, 1 parity even bit and 1 stop bit.

The following bit rates are supported: 300, 2400 and 9600 baud.

The U1000 MKII WM will only respond to M-Bus requests while operational, while the flow reading, volume total, energy total, power or temperature screens are displayed.

The M-Bus module supports the following functions:

- Acknowledge Function
- Slave Select Function
- Data Transfer Functions
- Switch Baud Rate Function
- Change Primary Address Function

4.4.1 Acknowledge Function

COMMAND:	ACK		
DESCRIPTION:	Response from the slave denoting that a message was received from the master.		
DIRECTION:	SLAVE TO MASTER		
FRAME TYPE:	ACK FRAME		
NAME	CODE		
ACKNOWLEDGE	0xE5		

4.4.2 Select Slave Function

COMMAND:	SEND_NKE		
DESCRIPTION:	Initialise / Reset slave device for communications.		
DIRECTION:	MASTER TO SLAVE		
FRAME TYPE:	SHORT / LONG FRAME		
PRIMARY ADDRESSING			
NAME		CODE	
START	0x10	START	0x68
(C - FIELD) INITIALISE SLAVE	0x40	LENGTH	0x0B
(A - FIELD) SLAVE PRIMARY ADDRESS	0xXX	LENGTH	0x0B
CHECKSUM	0xXX	START	0x68
STOP	0x16	(C – FIELD) INITIALISE SLAVE	0x73
		(A – FIELD) USE SECONDARY ADDRESSING	0xFD
		(CI – FIELD) INITIALISE SLAVE	0x52
		M-Bus IIN (BYTE 1)	0xXX
		M-Bus IIN (BYTE 2)	0xXX
		M-Bus IIN (BYTE 3)	0xXX
		M-Bus IIN (BYTE 4)	0xXX
		MANF. ID (BYTE 1)	0xCD
		MANF. ID (BYTE 2)	0x54
		VERSION NUMBER	0x01
		DEVICE TYPE ID	0x04
		CHECKSUM	0xXX
		STOP	0x16

MASTER TO SLAVE: SEND_NKE

SLAVE TO MASTER: ACK

4.4.3 Data Transfer Functions

No	VARIABLE	TYPE	SELECTION BITS
1	FLOW RATE	IEEE754 FLOAT	LITRES / MINUTE
2	ENERGY	IEEE754 FLOAT	kWh
3	POWER	IEEE754 FLOAT	kW
4	TEMPERATURE (COLD)	IEEE754 FLOAT	CELCIUS
5	TEMPERATURE (HOT)	IEEE754 FLOAT	CELCIUS
6	TEMPERATURE (DIFFERENCE)	IEEE754 FLOAT	CELCIUS

4.4.4 REQ_UD2 – REQUEST DATA

COMMAND:		REQ_UD2 – REQUEST DATA	
DESCRIPTION:			
DIRECTION:		MASTER TO SLAVE	
FRAME TYPE:		CONTROL / LONG FRAME	
PRIMARY ADDRESSING		SECONDARY ADDRESSING	
NAME	CODE	NAME	CODE
START	0x68	START	0x68
LENGTH	0x04	LENGTH	0x0C
LENGTH	0x04	LENGTH	0x0C
START	0x68	START	0x68
(C - FIELD) SEND_UD	0x73	(C - FIELD) SEND_UD	0x73
(A - FIELD) SLAVE PRIMARY ADDRESS	0xXX	(A - FIELD) USE SECONDARY ADDRESSING	0xFD
(CI – FIELD) SEND DATA TO SLAVE	0x51	(CI – FIELD) SEND DATA TO SLAVE	0x51
DIF: REQUEST ALL DATA	0x7F	M-Bus IIN (BYTE 1)	0xXX
CHECKSUM	0xXX	M-Bus IIN (BYTE 2)	0xXX
STOP	0x16	M-Bus IIN (BYTE 3)	0xXX
		M-Bus IIN (BYTE 4)	0xXX
		MANF. ID (BYTE 1)	0xCD
		MANF. ID (BYTE 2)	0x54
		VERSION NUMBER	0x01
		DEVICE TYPE ID	0x04
		DIF: REQUEST ALL DATA	0x7F
		CHECKSUM	0xXX
		STOP	0x16

MASTER TO SLAVE: SEND_NKE

SLAVE TO MASTER: ACK

MASTER TO SLAVE: REQ_UD2 – REQUEST DATA

SLAVE TO MASTER: RSP_UD2 – RETURN DATA

4.4.5 RSP_UD2 – RETURN DATA

COMMAND:	RSP_UD2 – RETURN DATA			
DESCRIPTION:				
DIRECTION:	SLAVE TO MASTER			
FRAME TYPE:	LONG FRAME			
NAME	DESCRIPTION	SIZE	CODE	
START		1	0x68	
LENGTH		1	0xXX	
LENGTH		1	0xXX	
START		1	0x68	
(C - FIELD)	RSP_UD	1	0x08	
(A - FIELD)	SLAVE PRIMARY ADDRESS	1	0xXX	
(CI – FIELD)	RETURN DATA FROM SLAVE	1	0x72	
M-Bus IIN (BYTE 1)	12-BYTE FRAME HEADER	1	0xXX	
M-Bus IIN (BYTE 2)		1	0xXX	
M-Bus IIN (BYTE 3)		1	0xXX	
M-Bus IIN (BYTE 4)		1	0xXX	
MANF. ID (BYTE 1)		1	0xCD	
MANF. ID (BYTE 2)		1	0x54	
VERSION NUMBER		1	0x01	
DEVICE TYPE ID		1	0x04	
ACCESS NUMBER		1	0xXX	
M-Bus INTERFACE STATUS		1	0xXX	
SIGNATURE 1		1	0x00	
SIGNATURE 2		1	0x00	
DATA BLOCK 1				
DATA BLOCK 2				
DATA BLOCK 3				
DATA BLOCK 4				
DATA BLOCK 5				
DATA BLOCK 6				
DIF	0x0F IDENTIFIES LAST BLOCK	1	0x0F	
CHECKSUM		1	0xXX	
STOP		1	0x16	

MASTER TO SLAVE: SEND_NKE

SLAVE TO MASTER: ACK

MASTER TO SLAVE: REQ_UD2 – REQUEST DATA

SLAVE TO MASTER: RSP_UD2 – RETURN DATA

4.4.6 Switch Baud Rate Function

SEND_UD - SET BAUD RATE 300

COMMAND:	SEND_UD – SET BAUD RATE 300		
DESCRIPTION:	Sets the slave data rate to 300 baud. The slave responds to the request with ACK at the current baud and then modifies its baud setting. If the slave does not receive a message from the master at the new rate within 2 minutes, the slave defaults to a setting of 300 baud.		
DIRECTION:	MASTER TO SLAVE		
FRAME TYPE:	CONTROL / LONG FRAME		
PRIMARY ADDRESSING		SECONDARY ADDRESSING	
NAME	CODE	NAME	CODE
START	0x68	START	0x68
LENGTH	0x03	LENGTH	0x0B
LENGTH	0x03	LENGTH	0x0B
START	0x68	START	0x68
(C - FIELD) SEND_UD	0x73	(C - FIELD) SEND_UD	0x73
(A - FIELD) SLAVE PRIMARY ADDRESS	0xXX	(A - FIELD) USE SECONDARY ADDRESSING	0xFD
(CI – FIELD) SET BAUD RATE 300	0xB8	(CI – FIELD) SET BAUD RATE 300	0xB8
CHECKSUM	0xXX	M-Bus IIN (BYTE 1)	0xXX
STOP	0x16	M-Bus IIN (BYTE 2)	0xXX
		M-Bus IIN (BYTE 3)	0xXX
		M-Bus IIN (BYTE 4)	0xXX
		MANF. ID (BYTE 1)	0xCD
		MANF. ID (BYTE 2)	0x54
		VERSION NUMBER	0x01
		DEVICE TYPE ID	0x04
		CHECKSUM	0xXX
		STOP	0x16

MASTER TO SLAVE: SEND_NKE

SLAVE TO MASTER: ACK

MASTER TO SLAVE: SEND_UD – SET 300 BAUD

SLAVE TO MASTER: ACK

SEND_UD – SET BAUD RATE 2400

COMMAND:	SEND_UD – SET BAUD RATE 2400		
DESCRIPTION:	Sets the slave data rate to 2400 baud. The slave responds to the request with ACK at the current baud and then modifies its baud setting. If the slave does not receive a message from the master at the new rate within 2 minutes, the slave defaults to a setting of 300 baud.		
DIRECTION:	MASTER TO SLAVE		
FRAME TYPE:	CONTROL / LONG FRAME		
PRIMARY ADDRESSING		SECONDARY ADDRESSING	
NAME	CODE	NAME	CODE
START	0x68	START	0x68
LENGTH	0x03	LENGTH	0x0B
LENGTH	0x03	LENGTH	0x0B
START	0x68	START	0x68
(C - FIELD) SEND_UD	0x73	(C - FIELD) SEND_UD	0x73
(A - FIELD) SLAVE PRIMARY ADDRESS	0xXX	(A - FIELD) USE SECONDARY ADDRESSING	0xFD
(CI – FIELD) SET BAUD RATE 2400	0xBB	(CI – FIELD) SET BAUD RATE 2400	0xBB
CHECKSUM	0xXX	M-Bus IIN (BYTE 1)	0xXX
STOP	0x16	M-Bus IIN (BYTE 2)	0xXX
		M-Bus IIN (BYTE 3)	0xXX
		M-Bus IIN (BYTE 4)	0xXX
		MANF. ID (BYTE 1)	0xCD
		MANF. ID (BYTE 2)	0x54
		VERSION NUMBER	0x01
		DEVICE TYPE ID	0x04
		CHECKSUM	0xXX
		STOP	0x16

MASTER TO SLAVE: SEND_NKE

SLAVE TO MASTER: ACK

MASTER TO SLAVE: SEND_UD – SET 2400 BAUD

SLAVE TO MASTER: ACK

SEND_UD – SET BAUD RATE 9600

COMMAND:	SEND_UD – SET BAUD RATE 9600		
DESCRIPTION:	Sets the slave data rate to 9600 baud. The slave responds to the request with ACK at the current baud and then modifies its baud setting. If the slave does not receive a message from the master at the new rate within 2 minutes, the slave defaults to a setting of 300 baud.		
DIRECTION:	MASTER TO SLAVE		
FRAME TYPE:	CONTROL / LONG FRAME		
PRIMARY ADDRESSING		SECONDARY ADDRESSING	
NAME	CODE	NAME	CODE
START	0x68	START	0x68
LENGTH	0x03	LENGTH	0x0B
LENGTH	0x03	LENGTH	0x0B
START	0x68	START	0x68
(C - FIELD) SEND_UD	0x73	(C - FIELD) SEND_UD	0x73
(A - FIELD) SLAVE PRIMARY ADDRESS	0xXX	(A - FIELD) USE SECONDARY ADDRESSING	0xFD
(CI – FIELD) SET BAUD RATE 9600	0xBD	(CI – FIELD) SET BAUD RATE 9600	0xBD
CHECKSUM	0xXX	M-Bus IIN (BYTE 1)	0xXX
STOP	0x16	M-Bus IIN (BYTE 2)	0xXX
		M-Bus IIN (BYTE 3)	0xXX
		M-Bus IIN (BYTE 4)	0xXX
		MANF. ID (BYTE 1)	0xCD
		MANF. ID (BYTE 2)	0x54
		VERSION NUMBER	0x01
		DEVICE TYPE ID	0x04
		CHECKSUM	0xXX
		STOP	0x16

MASTER TO SLAVE: SEND_NKE

SLAVE TO MASTER: ACK

MASTER TO SLAVE: SEND_UD – SET 9600 BAUD

SLAVE TO MASTER: ACK

4.4.7 Change Primary Address Function

COMMAND:	SEND_UD – SET PRIMARY ADDRESS		
DESCRIPTION:	The primary address of the slave is set to a default value at power up. The master uses this command to assign a new unique primary address to the slave if required.		
DIRECTION:	MASTER TO SLAVE		
FRAME TYPE:	LONG FRAME		
PRIMARY ADDRESSING		SECONDARY ADDRESSING	
NAME	CODE	NAME	CODE
START	0x68	START	0x68
LENGTH	0x06	LENGTH	0x0E
LENGTH	0x06	LENGTH	0x0E
START	0x68	START	0x68
(C - FIELD) SEND_UD	0x73	(C - FIELD) SEND_UD	0x73
(A - FIELD) SLAVE PRIMARY ADDRESS	0xXX	(A - FIELD) USE SECONDARY ADDRESSING	0xFD
(CI – FIELD)	0x51	(CI – FIELD)	0x51
DIF: 8 BIT INTEGER	0x01	M-Bus IIN (BYTE 1)	0xXX
VIF: SET PRIMARY ADDRESS	0x7A	M-Bus IIN (BYTE 2)	0xXX
NEW PRIMARY ADDRESS VALUE	0xXX	M-Bus IIN (BYTE 3)	0xXX
CHECKSUM	0xXX	M-Bus IIN (BYTE 4)	0xXX
STOP	0x16	MANF. ID (BYTE 1)	0xCD
		MANF. ID (BYTE 2)	0x54
		VERSION NUMBER	0x01
		DEVICE TYPE ID	0x04
		DIF: 8 BIT INTEGER	0x01
		VIF: SET PRIMARY ADDRESS	0x7A
		NEW PRIMARY ADDRESS VALUE	0xXX
		CHECKSUM	0xXX
		STOP	0x16

MASTER TO SLAVE: SEND_NKE

SLAVE TO MASTER: ACK

MASTER TO SLAVE: SEND_UD – SET PRIMARY ADDRESS

SLAVE TO MASTER: ACK

5 APPENDIX

5.1 Specification

General	
Measuring Technique	Transit time
Measurement channels	1
Timing Resolution	±50ps
Turn down ratio	100:1
Flow velocity range	0.1 to 10m/s
Applicable Fluid types	Clean water with < 3% by volume of particulate content, or up to 30% ethylene glycol.
Accuracy	±3% of flow reading for velocity rate >0.3m/s
Repeatability	±0.15% of measured value
Pipe Ranges	25 - 115mm OD and 125 - 225mm OD Note: Pipe size is dependent on pipe material and internal diameter.
Selectable units for metric (mm)	Velocity: m/s Flow Rate: l/s, l/min, m ³ /min, m ³ /hr Volume: litres, m ³
Selectable units for Imperial (inches)	Velocity: ft/s Flow rate: gal/min, gal/hr, USgal/min, USgal/hr Volume: gals, USgals
Totaliser	14 digits with roll over to zero
Languages supported	English only
Power input	12 – 24V DC or 24V AC
Power consumption	7W (DC) or 7VA (AC) maximum
Pulse Output	
Output	Opto-isolated MOSFET volt free contact (NO/NC).
Isolation	1MΩ @ 100V
Pulse width	Default value 50ms; programmable range 3 – 99ms
Pulse repetition rate	Up to 166 pulses/sec (depending on pulse width)
Frequency mode	200 Hz maximum (Range 1-200)
Maximum load voltage/current	24V DC or 24V AC / 500mA
Current Output	
Output	4 – 20mA
Resolution	0.1% of full scale
Maximum load	620Ω
Isolation	1MΩ @ 100V
Alarm current	3.5mA
Modbus (if fitted)	
Format	RTU
Baud rate	1200, 2400, 4800, 9600, 19200, 38400
Data -Parity-Stop Bits	8-None-2, 8-None-1, 8-Odd-2, 8-Even-1

continued on next page

Modbus (if fitted) – continued	
Standards	PI-MBUS-300 Rev. J
Physical connection	RS485
Isolation	1MΩ @ 100V
Mbus (if fitted)	
Baud rate	300, 2400, 9600
Data -Parity-Stop Bits	8-Even-1
Standards	EN13757 / EN1434
Isolation	1MΩ @ 100V
Temperature sensors	<i>U1000MkII-WM Heat Meter versions only</i>
Type	PT100 Class B 4 wire
Range	0.1°C to 140.0°C (32.2°F to 284.0°F)
Resolution	0.1°C / 1°F
Sensor Accuracy	±0.725°C (±1.305°F)
Enclosure	
Material	Plastic Polycarbonate
Fixing	Wall mountable
Degree of Protection	IP68
Flammability Rating	UL94 V-2/HB
Dimensions	215mm x 125mm x 90mm
Weight	1.0 kg
Environmental	
Pipe temperature	0.1°C to 140°C
Operating temperature (Electronics)	0°C to 50°C
Storage temperature	-10°C to 60°C
Humidity	90% RH at 50°C Max
Maximum altitude	4,000 metres
Indoors/outdoors	Indoors
Wet locations	A location in which water or other liquid can drip, splash, or flow on or against electrical equipment.
Pollution degree	3: Conductive pollution or dry nonconductive pollution that becomes conductive due to condensation.
Display	
LCD	2 line x 16 characters
Viewing angle	Min 30°
Active area	58mm (W) x 11mm(H)
Keypad	
Format	4 key tactile feedback membrane keypad



Servicing or repairs to the unit can only be carried out by the manufacturer.

5.2 Default values

The settings will be configured at the factory for metric units. The following table lists the metric and imperial default values.

Parameter	Default Value	
	Metric	Imperial
Dimensions	mm	inches
Flow Units	l/min	USgal/min
Pipe size (ID)	1" to 4" pipes: 50 mm 4" to 8" pipes: 127 mm	1" to 4" pipes: 1.969 in 4" to 8" pipes: 5.000 in
Pulse Output	Off	Off
Energy per Pulse <i>(Heat Meter versions only)</i>	1kW	1kBTU
Volume per Pulse	10 litres	2.642 US gallons
Pulse Width	50 ms	50 ms
Damping	20 seconds	20 seconds
Calibration Factor	1.000	1.000
Zero Cut-off	0.02 m/s	0.07 ft/s
Zero Offset	0.000 m/s	0.000 ft/s

5.3 Limitations with Water-Glycol Mixtures

There is little available data on the specific heat capacity (K factor) for water glycol mixes and there is no practical method of determining the percentage of glycol in a system or the type of glycol in use. The flow calculations are based on a Water/Ethylene glycol mix of 30%.

In practical terms the results should not be considered more than an approximation as:

The fluid speed of sound can vary between 1480ms and 1578ms

No temperature compensation curve is available for water/glycol mixes,

The percentage of Glycol can vary the specific heat capacity from 1.00 to 1.6 J/M3 * K

The type of glycol added can change the specific heat capacity and fluid speed of sound considerably.

The Factory enabled user set-up of the application relies on the installer to set the correct operating parameters, a considerable variation in results can be obtained from incorrectly set-up units.

5.4 Positioning

For accurate measurements, the U1000MKII WM guide rail and sensors must be installed at a position where the fluid flows uniformly. Flow profile distortions can result from upstream disturbance such as bends, tees, valves, pumps and other similar obstructions. To ensure a uniform flow profile, the unit must be mounted away from any cause of flow disturbance.

As a guide, we suggest this is best achieved by ensuring there is a straight length of pipe upstream of the transducers of at least 10 times the pipe diameter, and 5 times the pipe diameter on the downstream side, as shown in Figure 3, but this may vary. Flow Measurements can be made on

shorter lengths of straight pipe, but when the transducers are mounted this close to any obstruction the resulting errors can be unpredictable.

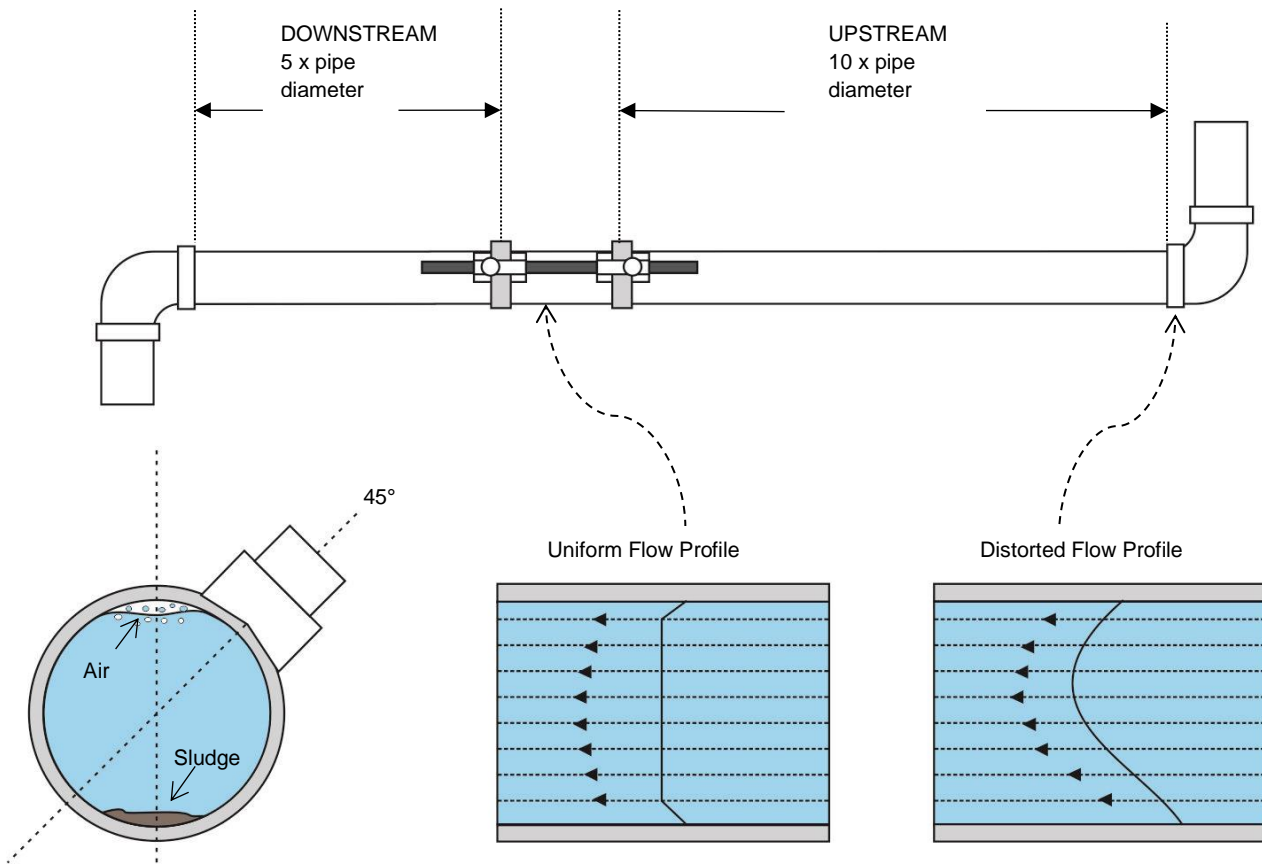

Figure 13 Location of unit

To obtain the most accurate results, the condition of both the liquid and the pipe must be suitable to allow ultrasound transmission along the predetermined path.

In many applications, an even flow velocity profile over a full 360° is unattainable due, for example, to the presence of air turbulence at the top of the flow and also possibly sludge at the bottom of the pipe. Experience has shown that the most consistently accurate results are achieved when the sensors are mounted at 45° with respect to the top of the pipe. In chiller applications, the U1000MKII WM sensor/electronics must be mounted at 45° with respect to the top of the pipe to prevent condensation entering the electronics unit.

IMPORTANT: DO NOT EXPECT TO OBTAIN ACCURATE RESULTS IF THE SENSORS ARE POSITIONED CLOSE TO ANY OBSTRUCTION THAT DISTORTS THE UNIFORMITY OF THE FLOW PROFILE. MICRONICS LTD ACCEPTS NO RESPONSIBILITY OR LIABILITY IF PRODUCT HAS NOT BEEN INSTALLED IN ACCORDANCE WITH THESE INSTRUCTIONS.

5.5 Error and Warning Messages

5.5.1 Error Messages

Error Messages are displayed as a number in the diagnostics menu. Contact Micronics if other messages appear.

Error Meaning	Status Byte								Value
	Bit#7	Bit#6	Bit#5	Bit#4	Bit#3	Bit#2	Bit#1	Bit#0	
RTD I2C failed <i>(Heat Meter versions only)</i>								1	1
RTD Thot failed <i>(Heat Meter versions only)</i>							1		2
RTD Tcold failed <i>(Heat Meter versions only)</i>						1			4
TOFM signal lost					1				8
TOFM board failed				1					16
TOFM window failed			1						32
TOFM sensor type failed		1							64
TOFM I2C failed	1								128

5.5.2 Example Error Messages

Error Message	Error Meaning
None or 0	None
2	Hot sensor error <i>(Heat Meter versions only)</i>
4	Cold sensor error <i>(Heat Meter versions only)</i>
6	Hot and Cold sensor error <i>(Heat Meter versions only)</i>
8	No flow signal
10	Hot error and no flow signal <i>(Heat Meter versions only)</i>
12	Cold error and no flow signal <i>(Heat Meter versions only)</i>
14	Hot and Cold error and no flow signal <i>(Heat Meter versions only)</i>

5.5.3 Modbus Error Messages (if Modbus fitted)

Test case	Transmitter							
	Address	Command	Start Register		Length (no of registers)		CRC-16	
	[1 byte]	[1 byte]	[2 bytes]		[2 bytes]		[2 bytes]	
No error	0x01	0x03	0x00	0x00	0x00	0x20	0x44	0x12
Incorrect function request	0x01	0x0C	0x00	0x00	0x00	0x20	0x10	0x13
Incorrect register start	0x01	0x03	0x00	0xEF	0x00	0x20	0x75	0xE7
Incorrect register length	0x01	0x03	0x00	0x12	0xFF	0x02	0x25	0xFE
Slave is busy	0x01	0x03	0x00	0x00	0x00	0x20	0x44	0x12
Incorrect CRC-16	0x01	0x03	0x00	0x20	0x00	0x20	0x44	0xFF

Receiver					Comments
Address	Command	Error code	CRC-16		
[1 byte]	[1 byte]	[1 byte]	[2 bytes]		
0x01	0x03	None	n/a	n/a	Example of a good message
0x01	0x8C	0x01	0x85	0x00	ILLEGAL FUNCTION - the only acceptable command is 0x03
0x01	0x83	0x02	0xC0	0xF1	ILLEGAL DATA ADDRESS - incorrect register start
0x01	0x83	0x03	0x01	0x31	ILLEGAL DATA VALUE - incorrect register length
0x01	0x83	0x06	0xC1	0x32	SLAVE DEVICE BUSY – U1000MkII WM is busy processing and is unable to respond
0x01	0x83	0x07	0x00	0xF2	CRC is incorrect

5.5.4 Flow Errors

A signal strength of less than 40% indicates poor set up of the instrument, and the installation should be checked or possibly moved to a different site.

5.5.5 Flow Warnings

A signal strength of less than 40% indicates poor set up of the instrument, and the installation should be checked or possibly moved to a different site. A negative flow is indicated by an "!" being displayed on the top line instead of a "*".

5.5.6 Data Entry Errors

These generally advise you that the data entered is not within the specified range:

Range 20.0 – 215.0
0.000 mm

Displayed when an invalid Pipe ID is entered, prompting the user to enter a value between 20 and 215 mm depending on the product purchased.

Calibrate Error
Press Enter

An attempt has been made to zero the offset between the temperature sensors, and the difference in temperature is too large. Ensure the temperature sensors are correctly plugged in and are both at the same temperature.

Range 1 - 200
200

When programming a Frequency Pulse output the frequency is limited to the range 1 to 200 Hz.

Range 3 - 99
0000.0

When programming a Volume Pulse output the pulse width is limited to the range 3 to 99ms.

Range 0.00 – 0.500
0000.0

When programming the Zero Cut-off this is limited to the range 0.000 to 0.500.

NOTE: THIS MUST BE SET TO ZERO BEFORE PERFORMING A ZERO OFFSET.

Range 0.500 – 1.500
0000.0

When programming the Calibration Factor this is limited to the range 0.5 to 1.5.

6 DECLARATION OF CONFORMITY

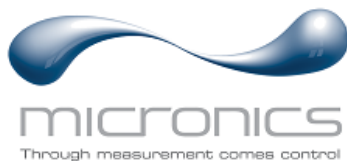

EU Declaration of Conformity Micronics Ltd

Knaves Beech Business Centre
Davies Way, Loudwater,
High Wycombe, Bucks.
HP10 9QR

The Products Covered by this Declaration: U1000MKII-FM, U1000MKII-HM, U1000MKII-WM

This product is manufactured in accordance with the following Directives and Standards:

Directive 2014/30/EU of the European Parliament and of the Council of 26 February 2014 on the approximation of the laws of the Member States relating to electromagnetic compatibility.

Directive 2014/35/EU of the European Parliament and of the Council of 26 February 2014 on the harmonisation of the laws of Member States relating to electrical equipment designed for use within certain voltage limits.

The Basis on which Conformity is being Declared

The Manufacturer hereby declares under his sole responsibility that the products identified above comply with the protection requirements of the EMC directive and with the principle elements of the safety objectives of the Low Voltage Equipment directive, and that the following standards have been applied:

BS EN61010-1:2010 Safety requirement for electrical equipment for measurement control and laboratory use. Part 1: General requirements.

BS EN61326-1:2013 Electrical equipment for measurement control and laboratory use EMC requirements. Part 1: General requirements.

BS EN61326-2-3:2013 Electrical equipment for measurement control and laboratory use EMC requirements. Part 2-3: Particular requirements – Test configuration and performance criteria for transducers and integrated or remote signal conditioning.

This declaration of conformity is issued under the sole responsibility of the manufacturer.

Signed for and on behalf of : Micronics Ltd.

Signature: 

Printed Name: Michael Farnon

Title: Managing Director

Date: November 2020

Location: Loudwater

Attention!

The attention of the specifier, purchaser, installer, or user is drawn to special measures and limitations to use which must be observed when these products are taken into service to maintain compliance with the above directives.

Details of these special measures and limitations to use are available on request, and also contained in the product manuals.

Registered Office: Micronics Limited, Knaves Beech Business Centre, Davies Way, Loudwater, Buckinghamshire. HP10 9QR.

Web site: www.micronicsflowmeters.com Tel: +44 (1628) 810456

Directors: E J Farnon, E Farnon, M A Farnon, D B Leigh

Registration No 1289680

VAT Registration No 303 6190 91

